

6 PT. IMPACT SOCKET

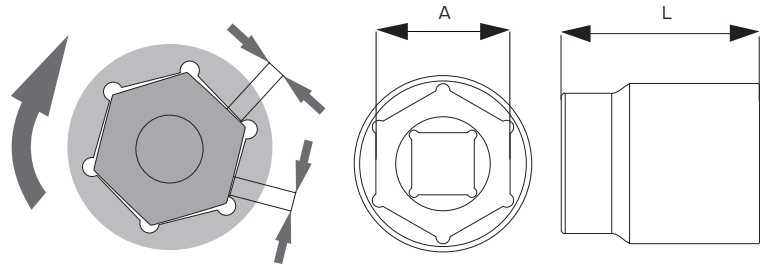

PRODUCT FEATURES

Standard-length and elongated PROLINE hexagonal impact socket is offered in a wide range of sizes. Cooperate with pneumatic devices, dedicated to difficult working conditions and changeable loads. Made from strong chromium-molybdenum (CrMo) steel thanks to which it has longer working lifetime, twice higher tensile strength and three times higher yield point than the ordinary sockets from chromium-vanadium tool steel. PROLINE socket has specially profiled rounded open angles between the work planes - PRO-DRIVE system - for mitigating excessive point loads accumulating in the internal edges of the socket. PRO-DRIVE system provides increased torque without the socket wall break, increases socket lifetime and protects the edges of the bolt head. Square socket is compatible with most locking mechanisms with renowned pneumatic devices. Delivered in a cardboard box or on a hanger.

1/2" 3/4" CrMo SCM-440 PRO DRIVE

CODE	SIZE GROUP	A [MM]	L [MM]		
18410	1/2"	10	39	-	60/240
18411	1/2"	11	39	-	60/240
18412	1/2"	12	39	-	60/240
18413	1/2"	13	39	-	60/240
18414	1/2"	14	39	-	60/120
18415	1/2"	15	39	-	40/160
18416	1/2"	16	39	-	40/160
18417	1/2"	17	39	-	40/160
18418	1/2"	18	39	-	40/160
18419	1/2"	19	39	-	40/160
18420	1/2"	20	39	-	40/160
18421	1/2"	21	39	-	40/160
18422	1/2"	22	39	-	30/120
18423	1/2"	23	39	-	30/120
18424	1/2"	24	43	-	30/120

6 PT. IMPACT SOCKET

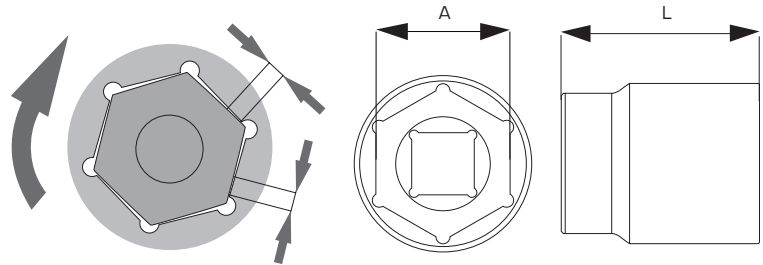

PRODUCT FEATURES

Standard-length and elongated PROLINE hexagonal impact socket is offered in a wide range of sizes. Cooperate with pneumatic devices, dedicated to difficult working conditions and changeable loads. Made from strong chromium-molybdenum (CrMo) steel thanks to which it has longer working lifetime, twice higher tensile strength and three times higher yield point than the ordinary sockets from chromium-vanadium tool steel. PROLINE socket has specially profiled rounded open angles between the work planes - PRO-DRIVE system - for mitigating excessive point loads accumulating in the internal edges of the socket. PRO-DRIVE system provides increased torque without the socket wall break, increases socket lifetime and protects the edges of the bolt head. Square socket is compatible with most locking mechanisms with renowned pneumatic devices. Delivered in a cardboard box or on a hanger.

1/2" **3/4"** **CrMo**
SCM-440 **PRO**
DRIVE

CODE	SIZE GROUP	A [MM]	L [MM]		
18425	1/2"	25	43	-	30/120
18426	1/2"	26	43	-	24/96
18427	1/2"	27	43	-	24/96
18428	1/2"	28	48	-	24/96
18429	1/2"	29	48	-	22/88
18430	1/2"	30	48	-	24/96
18432	1/2"	32	48	-	20/80
ZR18410	1/2"	10	39	x	60/240
ZR18411	1/2"	11	39	x	60/240
ZR18412	1/2"	12	39	x	60/240
ZR18413	1/2"	13	39	x	60/240
ZR18414	1/2"	14	39	x	60/120
ZR18415	1/2"	15	39	x	40/160
ZR18416	1/2"	16	39	x	40/160
ZR18417	1/2"	17	39	x	40/160

6 PT. IMPACT SOCKET

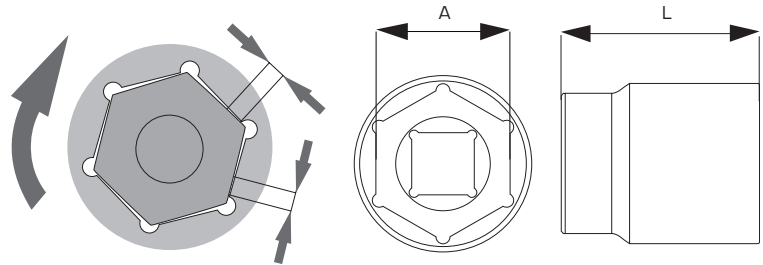

PRODUCT FEATURES

Standard-length and elongated PROLINE hexagonal impact socket is offered in a wide range of sizes. Cooperate with pneumatic devices, dedicated to difficult working conditions and changeable loads. Made from strong chromium-molybdenum (CrMo) steel thanks to which it has longer working lifetime, twice higher tensile strength and three times higher yield point than the ordinary sockets from chromium-vanadium tool steel. PROLINE socket has specially profiled rounded open angles between the work planes - PRO-DRIVE system - for mitigating excessive point loads accumulating in the internal edges of the socket. PRO-DRIVE system provides increased torque without the socket wall break, increases socket lifetime and protects the edges of the bolt head. Square socket is compatible with most locking mechanisms with renowned pneumatic devices. Delivered in a cardboard box or on a hanger.

1/2" **3/4"** **CrMo**
SCM-440 **PRO**
DRIVE

CODE	SIZE GROUP	A [MM]	L [MM]		
ZR18418	1/2"	18	39	x	40/160
ZR18419	1/2"	19	39	x	40/160
ZR18420	1/2"	20	39	x	40/160
ZR18421	1/2"	21	39	x	40/160
ZR18422	1/2"	22	39	x	30/120
ZR18423	1/2"	23	39	x	30/120
ZR18424	1/2"	24	43	x	30/120
ZR18425	1/2"	25	43	x	30/120
ZR18426	1/2"	26	43	x	24/96
ZR18427	1/2"	27	43	x	24/96
ZR18428	1/2"	28	48	x	24/96
ZR18429	1/2"	29	48	x	22/88
ZR18430	1/2"	30	48	x	24/96
ZR18432	1/2"	32	48	x	20/80
18919	3/4"	19	50	-	16/64

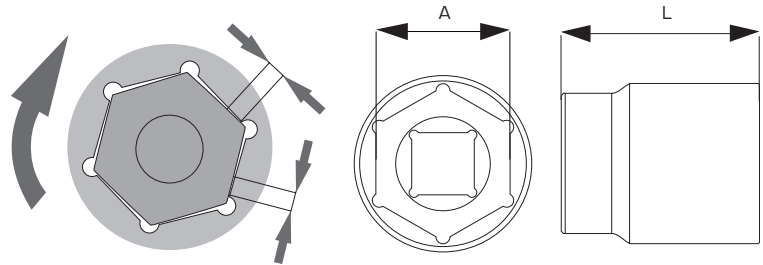

6 PT. IMPACT SOCKET



PRODUCT FEATURES

Standard-length and elongated PROLINE hexagonal impact socket is offered in a wide range of sizes. Cooperate with pneumatic devices, dedicated to difficult working conditions and changeable loads. Made from strong chromium-molybdenum (CrMo) steel thanks to which it has longer working lifetime, twice higher tensile strength and three times higher yield point than the ordinary sockets from chromium-vanadium tool steel. PROLINE socket has specially profiled rounded open angles between the work planes - PRO-DRIVE system - for mitigating excessive point loads accumulating in the internal edges of the socket. PRO-DRIVE system provides increased torque without the socket wall break, increases socket lifetime and protects the edges of the bolt head. Square socket is compatible with most locking mechanisms with renowned pneumatic devices. Delivered in a cardboard box or on a hanger.

1/2" 3/4" CrMo SCM-440 PRO DRIVE

CODE	SIZE GROUP	A [MM]	L [MM]		
18921	3/4"	21	50	-	16/64
18922	3/4"	22	50	-	16/64
18923	3/4"	23	50	-	16/64
18924	3/4"	24	50	-	16/64
18925	3/4"	25	50	-	16/64
18926	3/4"	26	50	-	16/64
18927	3/4"	27	53	-	16/64
18928	3/4"	28	53	-	16/64
18929	3/4"	29	53	-	12/48
18930	3/4"	30	53	-	12/48
18932	3/4"	32	56	-	12/48
18933	3/4"	33	56	-	8/32
18934	3/4"	34	56	-	8/32
18935	3/4"	35	56	-	6/24
18936	3/4"	36	56	-	6/24

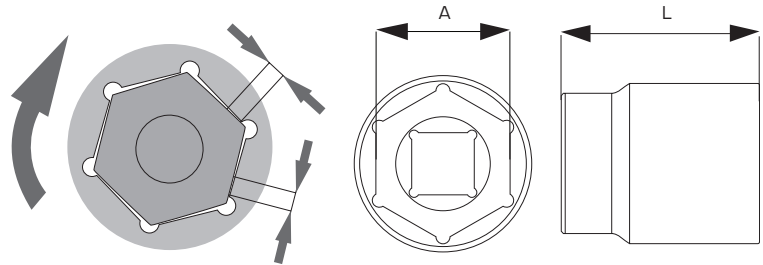

6 PT. IMPACT SOCKET



PRODUCT FEATURES

Standard-length and elongated PROLINE hexagonal impact socket is offered in a wide range of sizes. Cooperate with pneumatic devices, dedicated to difficult working conditions and changeable loads. Made from strong chromium-molybdenum (CrMo) steel thanks to which it has longer working lifetime, twice higher tensile strength and three times higher yield point than the ordinary sockets from chromium-vanadium tool steel. PROLINE socket has specially profiled rounded open angles between the work planes - PRO-DRIVE system - for mitigating excessive point loads accumulating in the internal edges of the socket. PRO-DRIVE system provides increased torque without the socket wall break, increases socket lifetime and protects the edges of the bolt head. Square socket is compatible with most locking mechanisms with renowned pneumatic devices. Delivered in a cardboard box or on a hanger.

1/2" **3/4"** **CrMo**
SCM-440 **PRO**
DRIVE

CODE	SIZE GROUP	A [MM]	L [MM]		
18938	3/4"	38	57	-	6/24
18941	3/4"	41	57	-	5/20
18942	3/4"	42	57	-	4/16
18943	3/4"	43	57	-	4/16
18946	3/4"	46	62	-	3/12
18948	3/4"	48	67	-	3/12
18950	3/4"	50	72	-	3/12
18952	3/4"	52	72	-	2/8
18955	3/4"	55	74	-	2/4
18960	3/4"	60	74	-	2/4
ZR18919	3/4"	19	50	x	16/64
ZR18921	3/4"	21	50	x	16/64
ZR18922	3/4"	22	50	x	16/64
ZR18923	3/4"	23	50	x	16/64
ZR18924	3/4"	24	50	x	16/64

6 PT. IMPACT SOCKET



PRODUCT FEATURES

Standard-length and elongated PROLINE hexagonal impact socket is offered in a wide range of sizes. Cooperate with pneumatic devices, dedicated to difficult working conditions and changeable loads. Made from strong chromium-molybdenum (CrMo) steel thanks to which it has longer working lifetime, twice higher tensile strength and three times higher yield point than the ordinary sockets from chromium-vanadium tool steel. PROLINE socket has specially profiled rounded open angles between the work planes - PRO-DRIVE system - for mitigating excessive point loads accumulating in the internal edges of the socket. PRO-DRIVE system provides increased torque without the socket wall break, increases socket lifetime and protects the edges of the bolt head. Square socket is compatible with most locking mechanisms with renowned pneumatic devices. Delivered in a cardboard box or on a hanger.

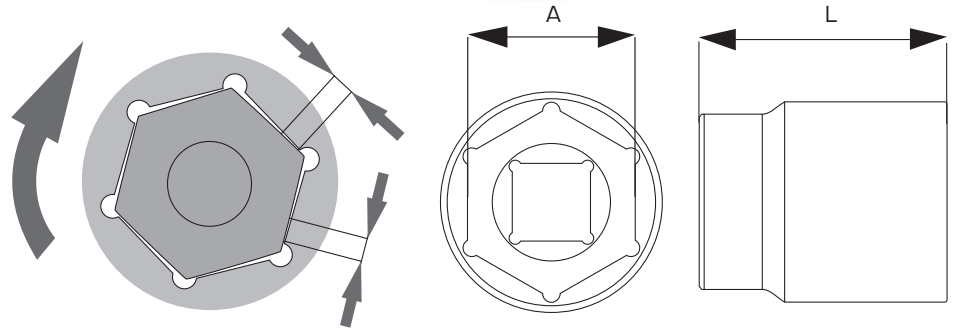

1/2" 3/4" CrMo SCM-440 PRO DRIVE

CODE	SIZE GROUP	A [MM]	L [MM]		
ZR18946	3/4"	46	62	x	3/12
ZR18948	3/4"	48	67	x	3/12
ZR18950	3/4"	50	72	x	3/12
ZR18952	3/4"	52	72	x	2/8
ZR18955	3/4"	55	74	x	2/4
ZR18960	3/4"	60	74	x	2/4